

J TRACK

120V Single Circuit Track System

WAC LIGHTING

Responsible Lighting®

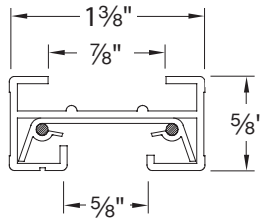

Fixture Type:

Catalog Number:

Project:

Location:

PRODUCT DESCRIPTION

Designed for nearly every application and interior environment, our extensive 120V Track collection offers hundreds of luminaires that integrate cutting edge design and aerospace detailing with designer glass and metal finishes. Versatile yet sturdy, the track systems can be surface mounted or suspended from the ceiling, liberating luminaires from the constraints of rigid mountings and enabling the lighting design to adapt to changing styles and spaces.

FEATURES

- May be field cut and easily installed on a variety of surfaces
- Available extension accessories
- Use compatible Quick Connect™ pendants and fixtures with each system
- End caps and mounting hardware included
- Retrofits into many popular track systems on the market today.

SPECIFICATIONS

Materials: Aluminum extrusion with copper bus wire.

Electrical: 20 Amps rated, 120V. It is common practice to use tracks at 80% capacity to insure compatibility with dimmers and connectors (1920W maximum).

Mounting: Can be installed on drywall, or suspended ceilings.

Standards: UL & CUL listed

Selecting Connectors (example using J Track)

In order to select the appropriate connectors to maintain electrical continuity, start at your power source and walk the length of the track. If you turn left, use a left connector. If you turn right, use a right connector.

Polarity is just a matter of matching ends
One side of an "J" Track has an indicator groove running its length

• Using a left connector, the track would run with the groove along the outside

• Using a right connector, the track would run with the groove along the inside

■ = Electrical Continuity

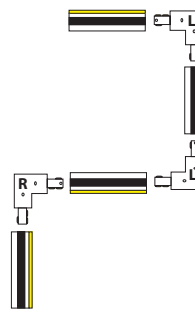
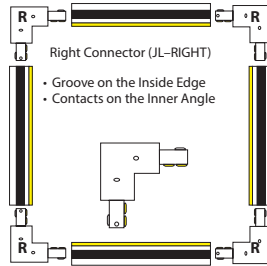
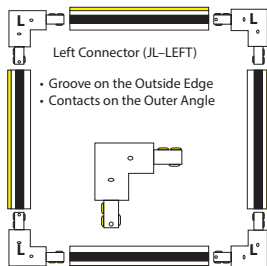

ORDER NUMBER

Model	Length	Finish
JT	2	BK Black BN Brushed Nickel WT White
	4	
	6	
	8	

Each section includes two matching end caps.



Example: **JT6-BN**

Sample Layout

A	SK18	18" Track suspension rod
B	JLE	Live end connector
C	JT2	2 foot Section of J Track
D	JL-LEFT	"J" Connector (Left)
E	J-LED17S-27	LEDme™ LED track head
F	J-ENDCAP	End Cap (included with track section)

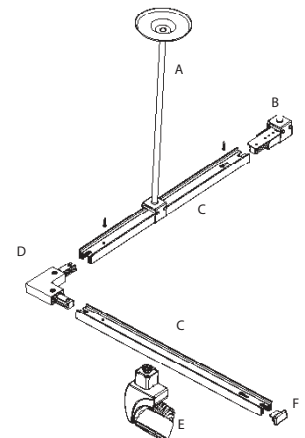

WAC Lighting

www.waclighting.com
Phone (800) 526.2588 • Fax (800) 526.2585

Headquarters/Eastern Distribution Center

44 Harbor Park Drive • Port Washington, NY 11050
Phone (516) 515.5000 • Fax (516) 515.5050

Western Distribution Center





















1750 Archibald Avenue • Ontario, CA 91760
Phone (800) 526.2588 • Fax (800) 526.2585

JTRACK

120V Single Circuit Track System

WAC LIGHTING

Responsible Lighting®

Accessories		Model	Finish	Description	Adapters		Model	Finish	Description					
Live End Connector		JLE	BK BN WT	4¾" × 1¼" × ¾" Use for direct wiring through ceiling. Canopy plate required when using with a junction box.	Quick Connect™ Adapter		EN-JQ50AR	BK BN WT	Connects pendant or fixture to track.					
Live End BX Connector		JBXLE	BK BN WT	6¼" × 1⅜" × 1¼" Use with surface mounted BX or non-metallic sheathed cable. Also provides through the ceiling connection.	Monopoint Canopy Adapter		JMP	BK BN WT	Mount a single system track fixture to a junction box.					
"I" Power Connector		JI-PWR	BK BN WT	7⅞" × 1⅜" × ¾" Power entry point at the connection of 2 tracks.										
"L" Connector Left		JL-LEFT	BK BN WT	4¼" × 4¼" × ¾" Use to join 2 track sections to make power feedable 90° left polarity turns.										
"L" Connector Right		JL-RIGHT	BK BN WT											
"T" Connector		JT	BK BN WT	7⅞" × 4¼" × ¾" Use to join 3 track sections. Power feedable on H and J only. "T" Connector with opposite polarity can be custom ordered.										
"X" Connector		JX	BK BN WT	7⅞" × 7⅞" × ¾" Use to join 4 track sections. Power feedable on H and J only.										
"I" Connector		JI	BK BN WT	3" × 1⅜" × ¾" Use to join two sections of track with electrical continuity.										
"I" Dead End Connector		JI-DEC	BK BN WT	3" × 1⅜" × ¾" Joins two sections of track without electrical continuity.										
Flexible Track Connector		JFLX	BK BN WT	8½" × 1⅜" × ¾" Connects two track sections at variable angles. Use as a transition from wall-to-wall, wall-to-ceiling, or ceiling-to-ceiling. Power feedable.										
Suspension Loop		J-LOOP	BK BN WT	1⅜" × 1⅜" × 3" 3" electrical loop accepts chain hung fixtures up to 35lbs. Contains compartment for electrical connections.										
15' Cord, Male Plug		HCORD	BK WT	15' Maximum capacity: 7A, 800W, 120V.										
T-Bar Drop Ceiling Attach		T-BARCLIP		1½" × 1¼" Attaches track to T-bar drop ceilings. Use two for 2 foot or 4 foot tracks, three for 6 foot or 8 foot tracks.										
Canopy Plate		CP	BK BN WT	4½" × 4½" Covers a standard 4" junction box. Use with any powerable connectors.										
Floating Canopy Connector		JFC	BK BN WT	4⅝" × 4⅝" × 1⅜" Connects to octagon box. Allows track to be powered anywhere along the length of the track.										
					Track Suspension		Model	Finish	Description					
					All Track Suspension Kit		SK	18 18"	BK BN WT	Extends track from ceiling. Includes track bracket, rod and ceiling canopy.				
								24 24"			36 36"	48 48"		
								Suspension Kit Extender			R	18 18" 24 24" 36 36" 48 48" 72 72"	BK BN WT	Use with Rod Coupler (RI) to further extend track from ceiling.
					Sloped Ceiling Adapter		SK14		BK BN WT	Use with suspension kits for sloped ceilings				
					Rod Coupler		RI		BK BN WT	Join two rods for suspensions longer than 48".				
					Suspension Adjustment Collar kit		SK05		BK BN WT	Used when suspension rod is field cut to custom lengths. One kit of two required for each rod. Includes two collars				
					Low Voltage Track Head Extension		X	6 6"	BK BN WT	Extends low voltage track heads from track. Specify extension, fixture and finish. Only available as complete unit.				
								12 12"			18 18"	24 24"		
								36 36"			48 48"			
								Wall Mount Suspension Bracket			TBKT 18"	BK BN WT	Extends track 24" from wall. Use two per 4' length, three per 8' length.	